

BYD Li-ion Battery Individual Data Sheets

LC0865

Specifications

Nominal Voltage		3.7V	
Capacity ¹ (mAh)	0.2C Discharge		
	Minimum	220mAh ²	
	Typical ³	250mAh	
Dimen- Sions		mm	inch
	Diameter	8.4 ⁰ _{-0.3}	0.330 ⁰ _{-0.012}
	Height	65.5 ⁰ _{-0.5}	2.579 ⁰ _{-0.020}
Weight [*]	Grams	Ounces	
		9	0.388
Internal impedance [*] at 1000Hz		< 180 mΩ (After charge)	
Charge	Standard	125mA(0.5C)×5hrs	
	Rapid	250mA(1C)×2.5hrs	
Ambient temperature		°C	°F
	Charge	0°C to 45°C	32°F to 113°F
	Discharge	-20°C to 60°C	-4°F to 140°F
	Storage	-20°C to 45°C	-4°F to 113°F

Charge characteristics

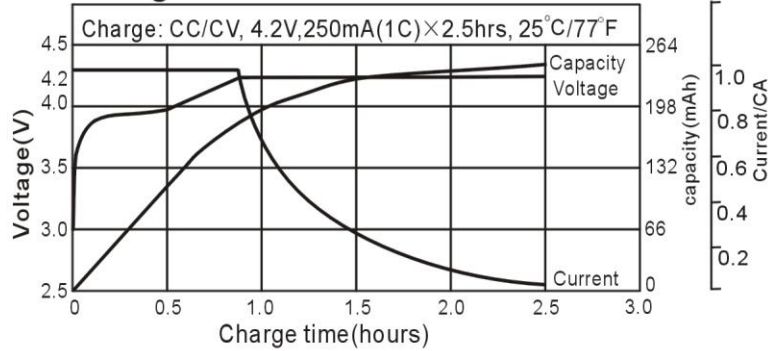

Discharge temperature characteristics

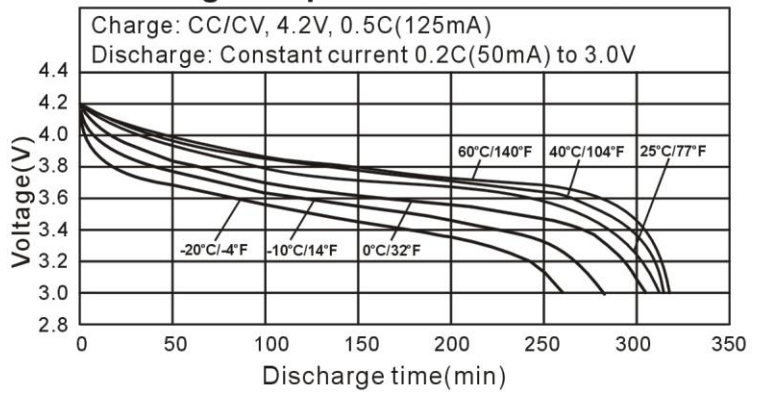

Dimensions(with tube)

(mm)

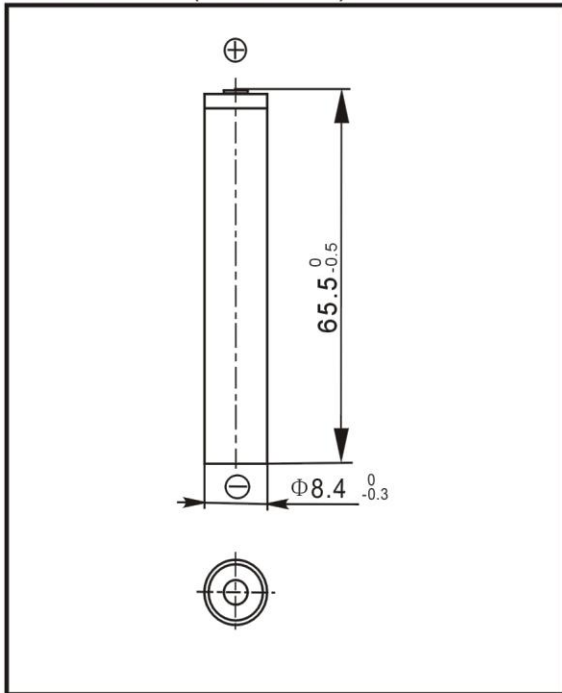

Cycle life characteristics

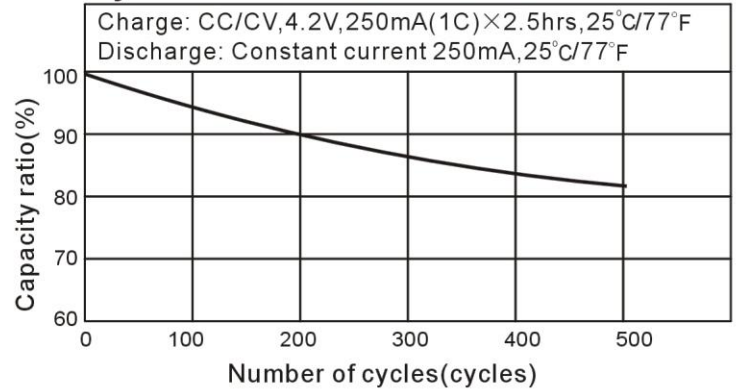

Storage characteristic

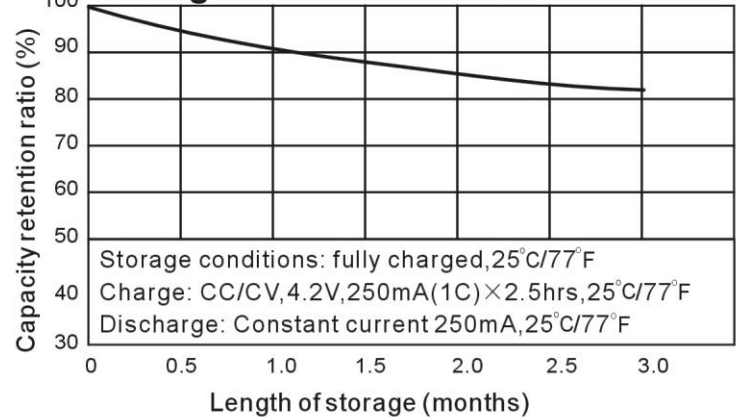

Note:

1. After charging at 1C for 2.5 hours.
 2. Nominal capacity, rated at 0.2C, 25°C/77°F.
 3. Average capacity. For reference only.
- *. Weight and internal impedance are for reference.