

BYD Li-ion Battery Individual Data Sheets

LP083467AR

Specifications

Nominal Voltage		3.7V	
Capacity ¹ (mAh)	0.2C Discharge		
	Minimum	1350mAh ²	
	Typical ³	1500mAh	
Dimen- Sions	Thickness	mm	inch
		8.2 ⁰ _{-0.5}	0.323 ⁰ _{-0.020}
		Width	33.8 ⁰ _{-0.5}
	Height	67.0 ⁰ _{-0.6}	2.638 ⁰ _{-0.024}
Weight [*]		Grams	Ounces
		39	1.45
Internal impedance [*] at 1000Hz		<70 mΩ (After charge)	
Charge	Standard	750mA(0.5C)×5hrs	
	Rapid	1500mA(1C)×2.5hrs	
Ambient temperature	Charge	°C	°F
		0°C to 45°C	32°F to 113°F
	Discharge	-20°C to 60°C	-4°F to 140°F
	Storage	-20°C to 45°C	-4°F to 113°F

Charge characteristics

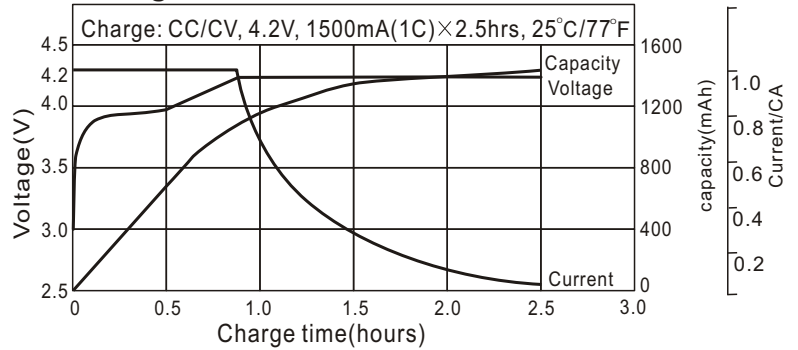

Discharge temperature characteristics

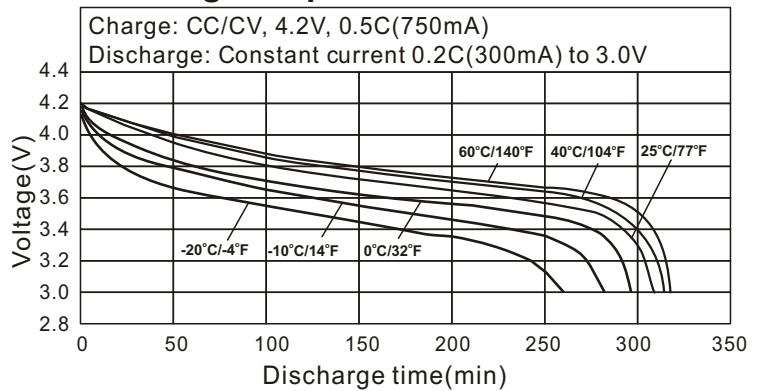

Dimensions(bare cell)

(mm)

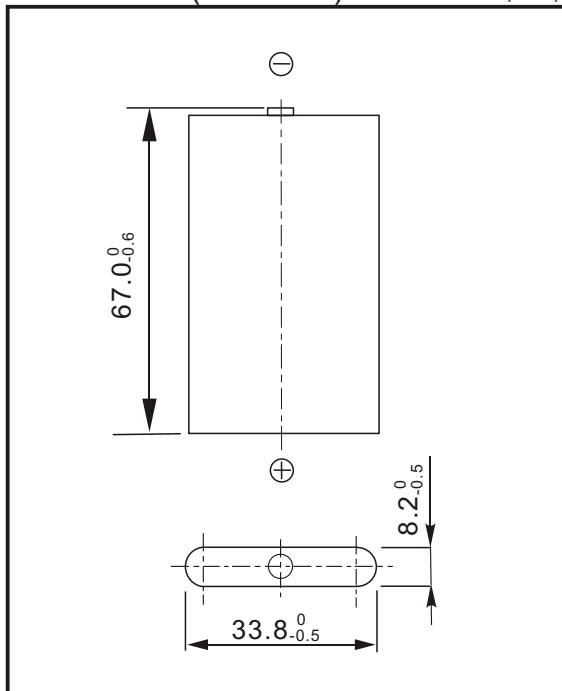

Note:

1. After charging at 1C for 2.5 hours.
 2. Nominal capacity, rated at 0.2C, 25°C/77°F.
 3. Average capacity. For reference only.
- *. Weight and internal impedance are for reference.

Cycle life characteristics

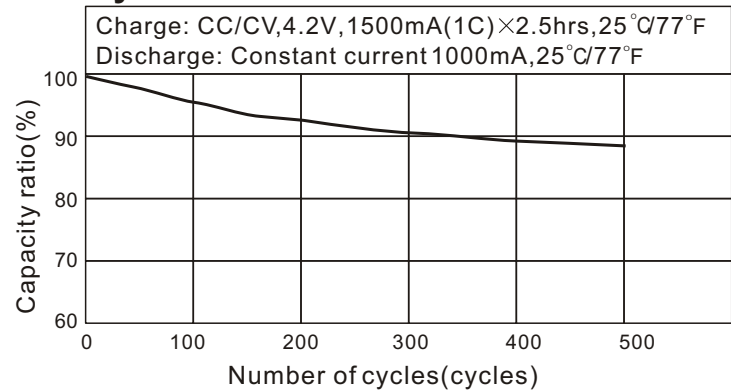

Storage characteristic

